

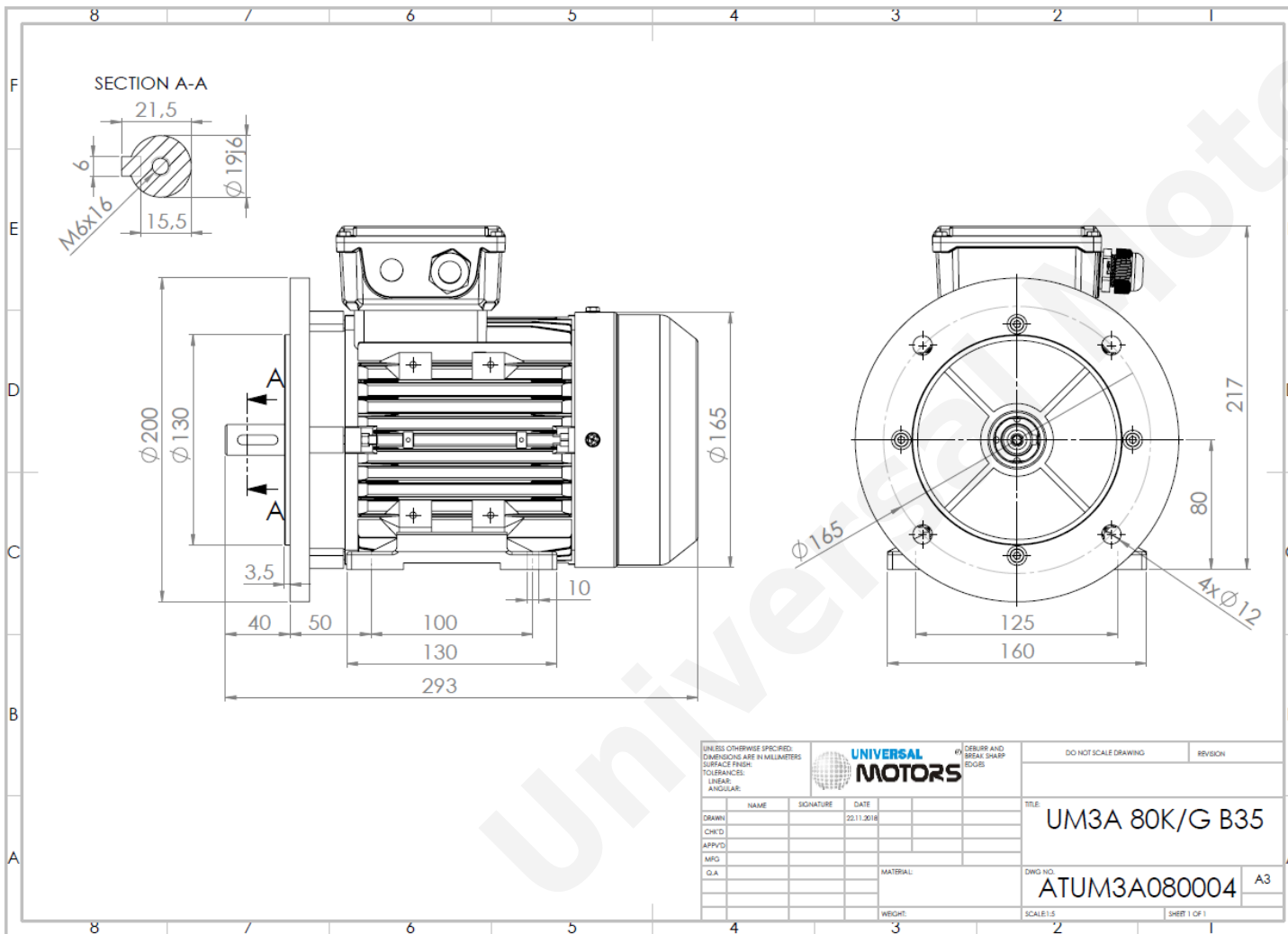

TECHNICAL DATA

Three Phase Electric Motors - Aluminum Frame
 PE31 80M1-2
 0.75 kW / 1 Cv
 2805 RPM



Motor type:	PE31 80M1-2
Output:	0.75 kW / 1 Cv
Speed (min ⁻¹):	2805 RPM
Frequency:	50 Hz
Voltage:	400 V
Current:	1.6 A
Power factor (Cos Ø):	0.83
Poles:	2
Insulation class:	F
Temperature rise Class:	B
Efficiency 50%:	78.7 %
Efficiency 75%:	79.5 %
Efficiency 100%:	80.7 %
Torque:	2.55 N.m
Tstarting/Tnominal:	2.3
Istarting/Inominal:	6.8
Tmaximum/Tnominal:	2.3
Noise:	74 Db(A)
Weight:	10 Kg
Bearing DE:	6204 2Z C3
Bearing NDE:	6204 2Z C3

Regime - S1

Altitude - 1000m

Environment Temperature - 40°C

CONTACTS:

UNIVERSAL MOTORS Tel: +351 252 299 080
 Rua de São Brás,745 Fax: +351 252 299 089
 4480-782 VILA DO CONDE Mail: geral@universalmotors.pt

* References applied only in the UK